

**Phase leg
NPT IGBT Power Module**

**$V_{CES} = 600V$
 $I_C = 180A @ T_c = 80^\circ C$**

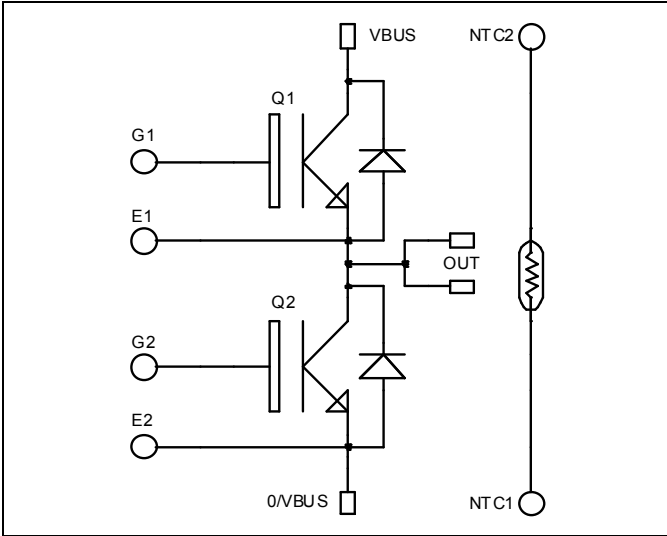

Application

- Welding converters
- Switched Mode Power Supplies
- Uninterruptible Power Supplies
- Motor control

Features

- Non Punch Through (NPT) THUNDERBOLT IGBT®
 - Low voltage drop
 - Low tail current
 - Switching frequency up to 100 kHz
 - Soft recovery parallel diodes
 - Low diode VF
 - Low leakage current
 - Avalanche energy rated
 - RBSOA and SCSOA rated
- Kelvin emitter for easy drive
- Very low stray inductance
 - Symmetrical design
 - Lead frames for power connections
- Internal thermistor for temperature monitoring
- High level of integration

Benefits

- Outstanding performance at high frequency operation
- Stable temperature behavior
- Very rugged
- Direct mounting to heatsink (isolated package)
- Low junction to case thermal resistance
- Solderable terminals both for power and signal for easy PCB mounting
- Easy paralleling due to positive TC of VCEsat
- Low profile

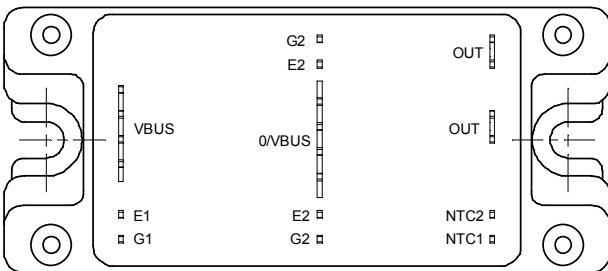

Absolute maximum ratings

Symbol	Parameter	Max ratings	Unit
V_{CES}	Collector - Emitter Breakdown Voltage	600	V
I_C	Continuous Collector Current	$T_c = 25^\circ C$	220
		$T_c = 80^\circ C$	180
I_{CM}	Pulsed Collector Current	$T_c = 25^\circ C$	630
V_{GE}	Gate - Emitter Voltage	± 20	V
P_D	Maximum Power Dissipation	$T_c = 25^\circ C$	833
RBSOA	Reverse Bias Safe Operating Area	$T_j = 150^\circ C$	630A @ 600V

CAUTION: These Devices are sensitive to Electrostatic Discharge. Proper Handling Procedures Should Be Followed.

All ratings @ $T_j = 25^\circ\text{C}$ unless otherwise specified

Electrical Characteristics

Symbol	Characteristic	Test Conditions	Min	Typ	Max	Unit
BV_{CES}	Collector - Emitter Breakdown Voltage	$V_{GE} = 0V, I_C = 150\mu A$	600			V
I_{CES}	Zero Gate Voltage Collector Current	$V_{GE} = 0V$ $V_{CE} = 600V$			150 3000	μA
$V_{CE(on)}$	Collector Emitter on Voltage	$V_{GE} = 15V$ $I_C = 180A$		2.0 2.2	2.5	V
$V_{GE(th)}$	Gate Threshold Voltage	$V_{GE} = V_{CE}, I_C = 2mA$	3		5	V
I_{GES}	Gate - Emitter Leakage Current	$V_{GE} = \pm 20V, V_{CE} = 0V$			± 200	nA

Dynamic Characteristics

Symbol	Characteristic	Test Conditions	Min	Typ	Max	Unit
C_{ies}	Input Capacitance	$V_{GE} = 0V$		8.6		nF
C_{oes}	Output Capacitance	$V_{CE} = 25V$		0.94		
C_{res}	Reverse Transfer Capacitance	$f = 1MHz$		0.8		
Q_g	Total gate Charge	$V_{GS} = 15V$		660		nC
Q_{ge}	Gate - Emitter Charge	$V_{Bus} = 300V$		580		
Q_{gc}	Gate - Collector Charge	$I_C = 180A$		400		
$T_{d(on)}$	Turn-on Delay Time	Inductive Switching (25°C)		26		ns
T_r	Rise Time	$V_{GE} = 15V$		25		
$T_{d(off)}$	Turn-off Delay Time	$V_{Bus} = 400V$		150		
T_f	Fall Time	$I_C = 180A$		30		
E_{on}	Turn-on Switching Energy ①	$R_G = 2.5 \Omega$		6.74		
E_{off}	Turn-off Switching Energy ②			5.74		mJ
$T_{d(on)}$	Turn-on Delay Time	Inductive Switching (125°C)		26		ns
T_r	Rise Time	$V_{GE} = 15V$		25		
$T_{d(off)}$	Turn-off Delay Time	$V_{Bus} = 400V$		170		
T_f	Fall Time	$I_C = 180A$		40		
E_{on}	Turn-on Switching Energy ①	$R_G = 2.5 \Omega$		8.6		
E_{off}	Turn-off Switching Energy ②			7		mJ

Reverse diode ratings and characteristics

Symbol	Characteristic	Test Conditions	Min	Typ	Max	Unit
$I_{F(AV)}$	Maximum Average Forward Current	50% duty cycle $T_c = 70^\circ\text{C}$		120		A
V_F	Diode Forward Voltage	$I_F = 120A$		1.6	1.8	V
		$I_F = 240A$		1.9		
		$I_F = 120A$ $T_j = 125^\circ\text{C}$		1.4		
t_{rr}	Reverse Recovery Time	$I_F = 120A$ $V_R = 400V$ $di/dt = 800A/\mu s$		85 160		ns
Q_{rr}	Reverse Recovery Charge	$I_F = 120A$ $V_R = 400V$ $di/dt = 800A/\mu s$		520 2800		nC

① E_{on} includes diode reverse recovery

② In accordance with JEDEC standard JESD24-1

Thermal and package characteristics

Symbol	Characteristic	Min	Typ	Max	Unit	
R _{thJC}	Junction to Case	IGBT		0.15	°C/W	
		Diode		0.32		
V _{ISOL}	RMS Isolation Voltage, any terminal to case t=1 min, I _{isol} <1mA, 50/60Hz	2500			V	
T _J	Operating junction temperature range	-40		150	°C	
T _{STG}	Storage Temperature Range	-40		125		
T _C	Operating Case Temperature	-40		100		
Torque	Mounting torque		To Heatsink	M5	4.7	N.m
Wt	Package Weight				160	g

Temperature sensor NTC

Symbol	Characteristic	Min	Typ	Max	Unit
R ₂₅	Resistance @ 25°C		68		kΩ
B _{25/85}	T ₂₅ = 298.16 K		4080		K

$$R_T = \frac{R_{25}}{\exp\left[B_{25/85}\left(\frac{1}{T_{25}} - \frac{1}{T}\right)\right]}$$

T: Thermistor temperature
R_T: Thermistor value at T

Package outline

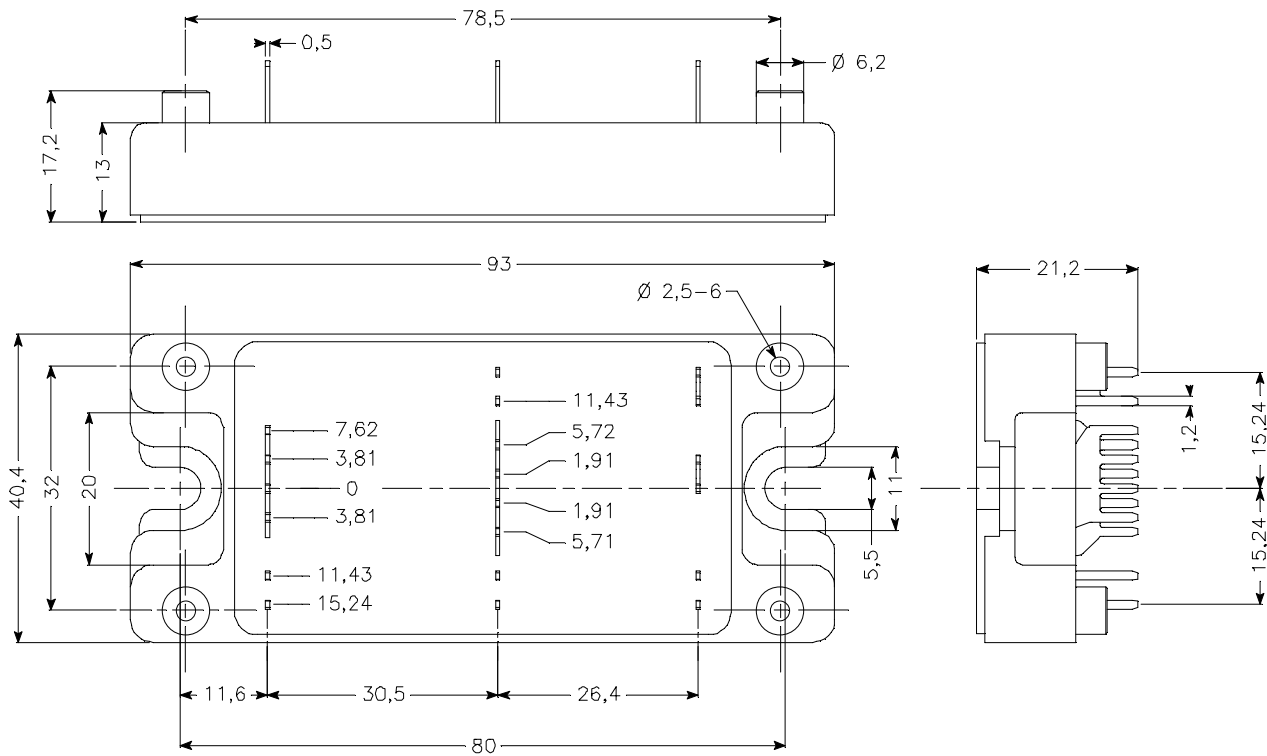

Typical Performance Curve

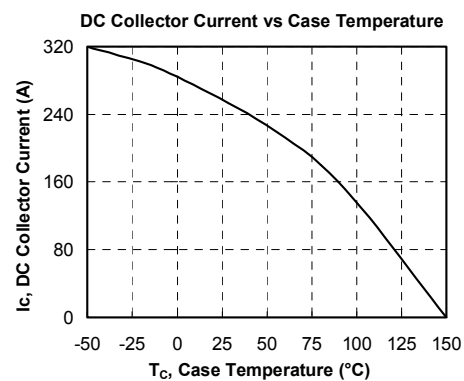
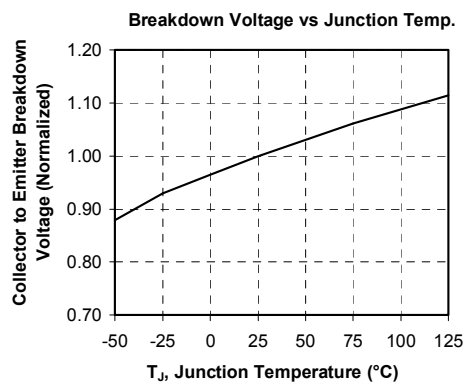
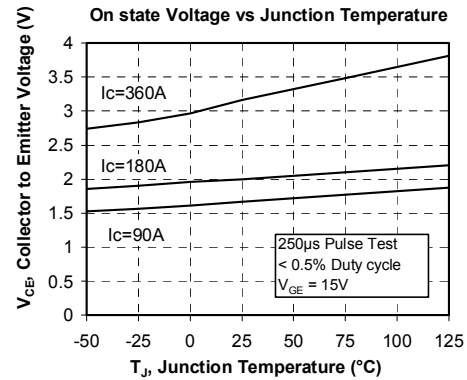
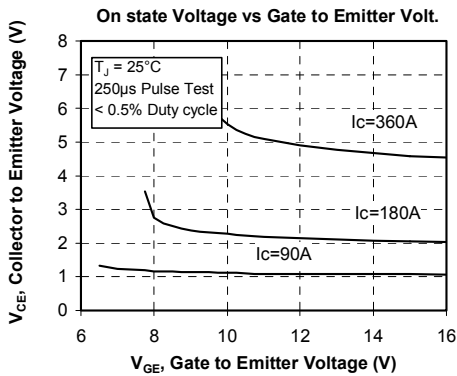
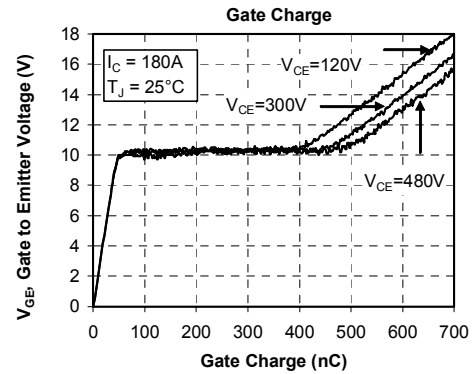
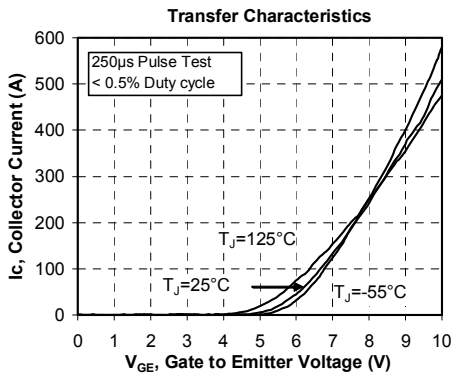
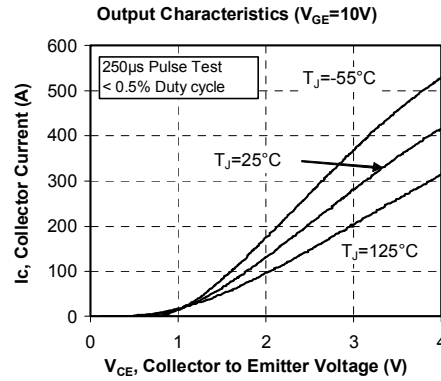
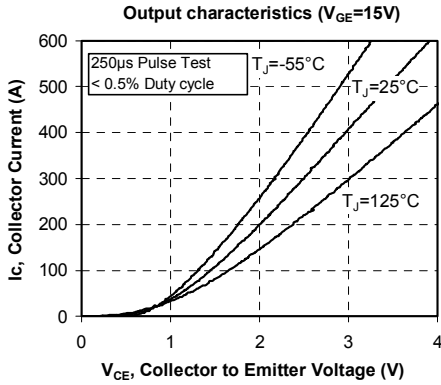

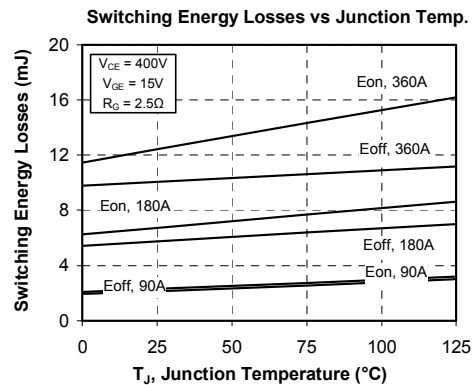
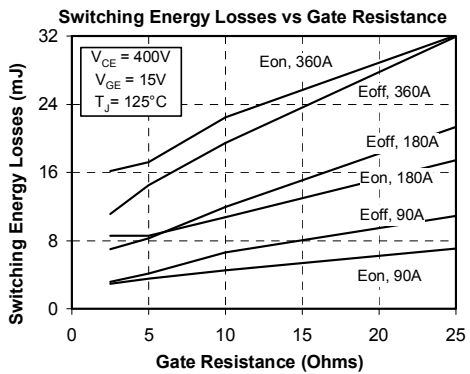
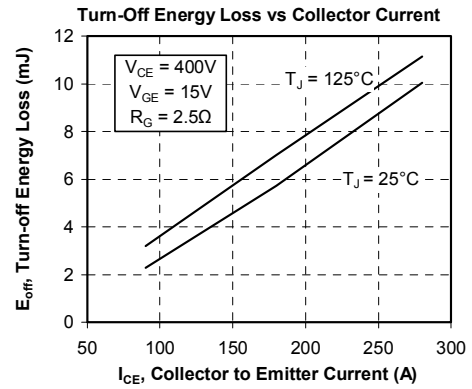
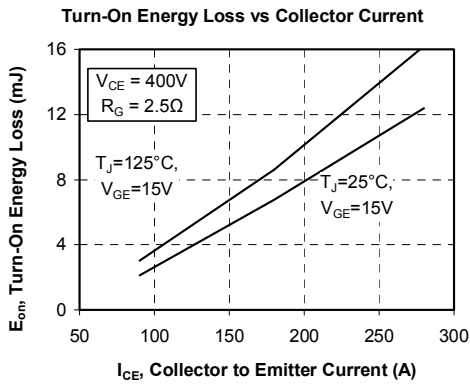
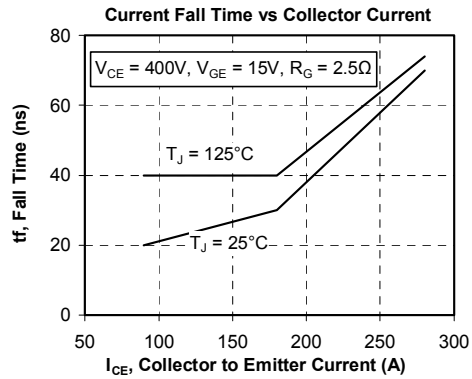
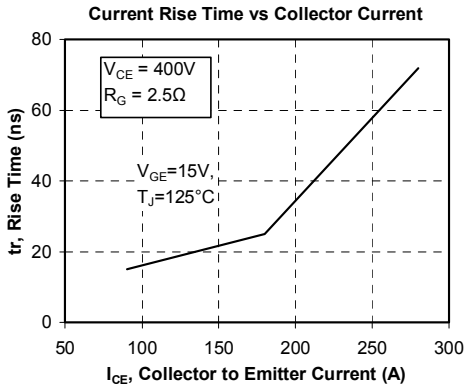
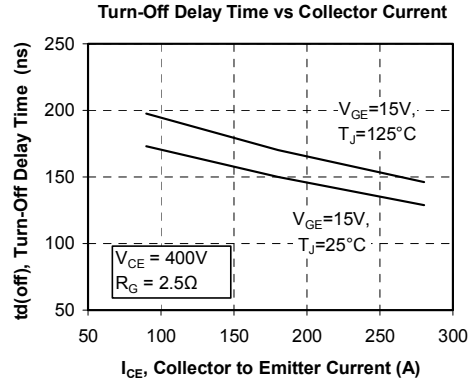
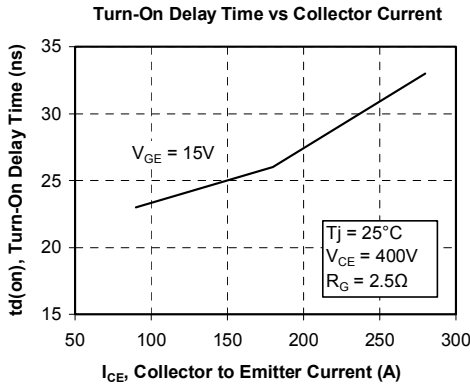

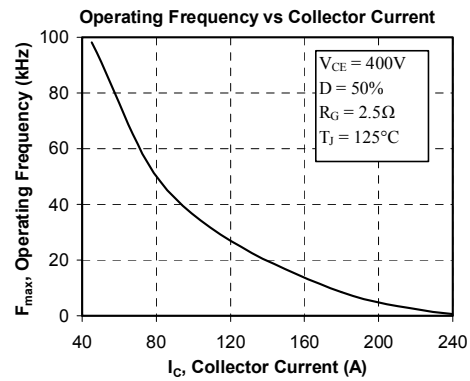
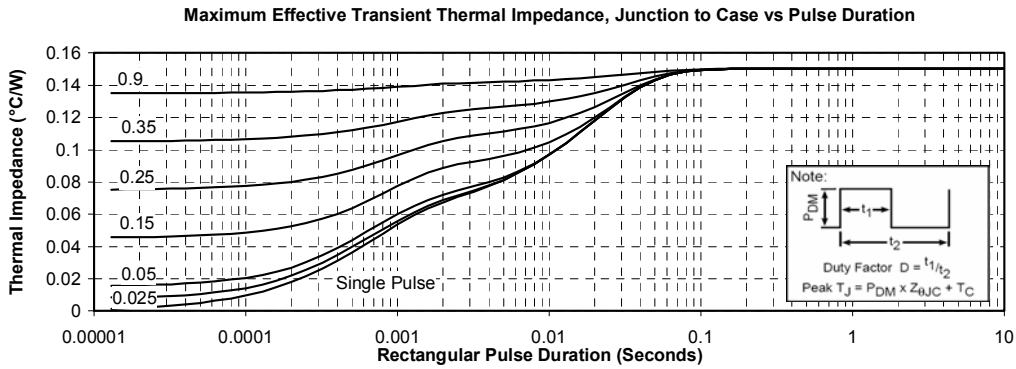
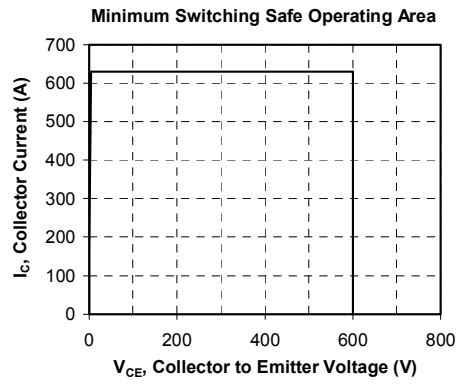
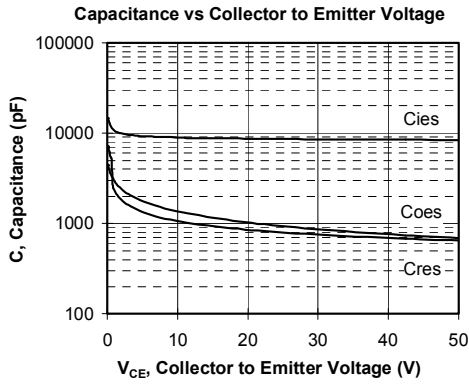

APT reserves the right to change, without notice, the specifications and information contained herein

APT's products are covered by one or more of U.S. patents 4,895,810 5,045,903 5,089,434 5,182,234 5,019,522 5,262,336 6,503,786 5,256,583 4,748,103 5,283,202 5,231,474 5,434,095 5,528,058 and foreign patents. U.S and Foreign patents pending. All Rights Reserved.